

Kabelstecker, schirmbar, IP67
Male cable connector, shieldable, IP67

Kabeldose, schirmbar, IP67
Female cable connector, shieldable, IP67

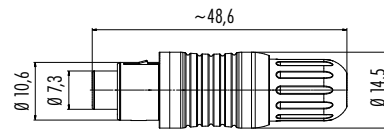
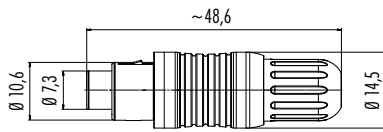

Polzahl Contacts	Kabeldurchlass Cable outlet	Bestell-Nr. Ordering-No.
3	3,5–5 mm	99 4905 00 03
4	3,5–5 mm	99 4909 00 04
5	3,5–5 mm	99 4913 00 05
7	3,5–5 mm	99 4925 00 07
8	3,5–5 mm	99 4929 00 08

Polzahl Contacts	Kabeldurchlass Cable outlet	Bestell-Nr. Ordering-No.
3	3,5–5 mm	99 4906 00 03
4	3,5–5 mm	99 4910 00 04
5	3,5–5 mm	99 4914 00 05
7	3,5–5 mm	99 4926 00 07
8	3,5–5 mm	99 4930 00 08

Polzahl	3	4	5	7	8	Number of contacts
Steckverbinder Verriegelung	Push-Pull					Connector locking system
Anschlussart	löten/solder					Termination
Anschlussquerschnitt	0,25 mm ² (AWG 24)			0,14 mm ² (AWG 26)		Wire gauge
Kabeldurchlass	3,5–5 mm					Cable outlet
Schutzart	IP67					Degree of protection
Mechanische Lebensdauer	> 500 Steckzyklen/> 500 mating cycles					Mechanical operation
Obere Grenztemperatur	+ 85 °C					Upper temperature
Untere Grenztemperatur	– 25 °C					Lower temperature
Bemessungsspannung	125 V					Rated voltage
Bemessungs-Stoßspannung	1500 V					Rated impulse voltage
Verschmutzungsgrad	1					Pollution degree
Überspannungskategorie	II					Overvoltage categorie
Isolierstoffgruppe	III					Material group
Bemessungsstrom (40°C)	4 A	3 A		1 A		Rated current (40 °C)
Material Kontakt	Stift/pin CuZn (Messing/brass), Buchse/socket CuSn (Bronze/bronze)					Material of contact
Kontaktoberfläche	Au (Gold/gold)					Contact plating
Material Kontaktkörper	PBT/PA					Material of contact body
Material Gehäuse	PA					Material of housing
Material Verriegelung	PA					Material of locking

Flanschstecker
Male panel mount connector

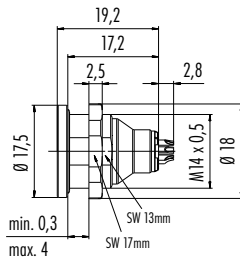

Flanschstecker, von vorn verschraubbar
Male panel mount connector, front fastened

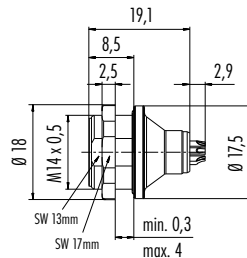

Flanschdose
Female panel mount connector

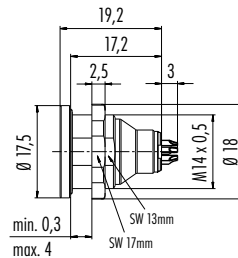

Flanschdose, von vorn verschraubbar
Female panel mount connector, front fastened

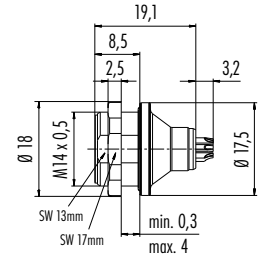

Schutzart Protection	Polzahl Contacts	Bestell-Nr. Ordering-No.	Schutzart Protection	Polzahl Contacts	Bestell-Nr. Ordering-No.	Schutzart Protection	Polzahl Contacts	Bestell-Nr. Ordering-No.	Schutzart Protection	Polzahl Contacts	Bestell-Nr. Ordering-No.
IP40	3	09 4907 025 03	IP40	3	—	IP40	3	09 4908 025 03	IP40	3	—
	4	09 4911 025 04		4	—		4	09 4912 025 04		4	—
	5	—		5	—		5	09 4916 025 05		5	—
	7	09 4927 025 07		7	—		7	—		7	—
	8	09 4931 025 08		8	—		8	09 4932 025 08		8	—
IP67	3	09 4907 015 03	IP67	3	09 4907 080 03	IP67	3	09 4908 015 03	IP67	3	09 4908 080 03
	4	09 4911 015 04		4	—		4	09 4912 015 04		4	09 4912 080 04
	5	09 4915 015 05		5	09 4915 080 05		5	09 4916 015 05		5	09 4916 080 05
	7	09 4927 015 07		7	09 4927 080 07		7	09 4928 015 07		7	09 4928 080 07
	8	09 4931 015 08		8	09 4931 080 08		8	09 4932 015 08		8	09 4932 080 08
IP67 geschirmt/ shielded	3	09 4907 00 03	IP67 geschirmt/ shielded	3	09 4907 081 03	IP67 geschirmt/ shielded	3	09 4908 00 03	IP67 geschirmt/ shielded	3	09 4908 081 03
	4	09 4911 00 04		4	09 4911 081 04		4	09 4912 00 04		4	09 4912 081 04
	5	09 4915 00 05		5	09 4915 081 05		5	09 4916 00 05		5	09 4916 081 05
	7	—		7	09 4927 081 07		7	09 4928 00 07		7	09 4928 081 07
	8	09 4931 00 08		8	09 4931 081 08		8	09 4932 00 08		8	09 4932 081 08

Polzahl	3	4	5	7	8	Number of contacts
Steckverbinder Verriegelung			Push-Pull			Connector locking system
Anschlussart			löten/solder			Termination
Anschlussquerschnitt		0,25 mm ² (AWG 24)		0,14 mm ² (AWG 26)		Wire gauge
Kabeldurchlass			—			Cable outlet
Schutzart			IP40/IP67			Degree of protection
Mechanische Lebensdauer			> 500 Steckzyklen/> 500 mating cycles			Mechanical operation
Obere Grenztemperatur			+ 85 °C			Upper temperature
Untere Grenztemperatur			- 25 °C			Lower temperature
Bemessungsspannung			125 V			Rated voltage
Bemessungs-Stoßspannung			1500 V			Rated impulse voltage
Verschmutzungsgrad			1			Pollution degree
Überspannungskategorie			II			Overvoltage categorie
Isolierstoffgruppe			III			Material group
Bemessungsstrom (40°C)	4 A		3 A		1 A	Rated current (40 °C)
Material Kontakt		Stift/pin CuZn (Messing/brass), Buchse/socket CuSn (Bronze/bronze)				Material of contact
Kontaktoberfläche		Au (Gold/gold)				Contact plating
Material Kontaktkörper		PBT				Material of contact body
Material Gehäuse		CuZn (Messing vernickelt/brass nickel plated)				Material of housing
Material Verriegelung		—				Material of locking

Montageanleitung
Assembly instruction

1. Abmanteln auf L = 26mm. Ummantelung nicht abstreifen.
2. Druckschraube und Dichtung auf Kabel auffädeln. Dichtung in Klemmvorrichtung montieren. Ummantelung entfernen.
3. Abschirmung auffächern und auskämmen.
4. Litzen abisolieren und verzinnen.
5. Abstandshülse und Klemmvorrichtung verrasten.
6. Einsätze anlöten.
7. Abstandshülse auf Hülse stecken.
8. Klemmvorrichtung vorschieben und einrasten. Die Abschirmlitzen in der Krone rundherum einfädeln.
9. Abschirmlitzen in Richtung Abschirmring abstreifen und kürzen.
zu lang: Litzen auf Dichtring - undicht
zu kurz: kein Kontakt zu Wellenring
10. Montierte Einheit in Trägerhülse stecken. Dabei Position der Kodiernase beachten.
11. Druckschraube aufstecken und festziehen.

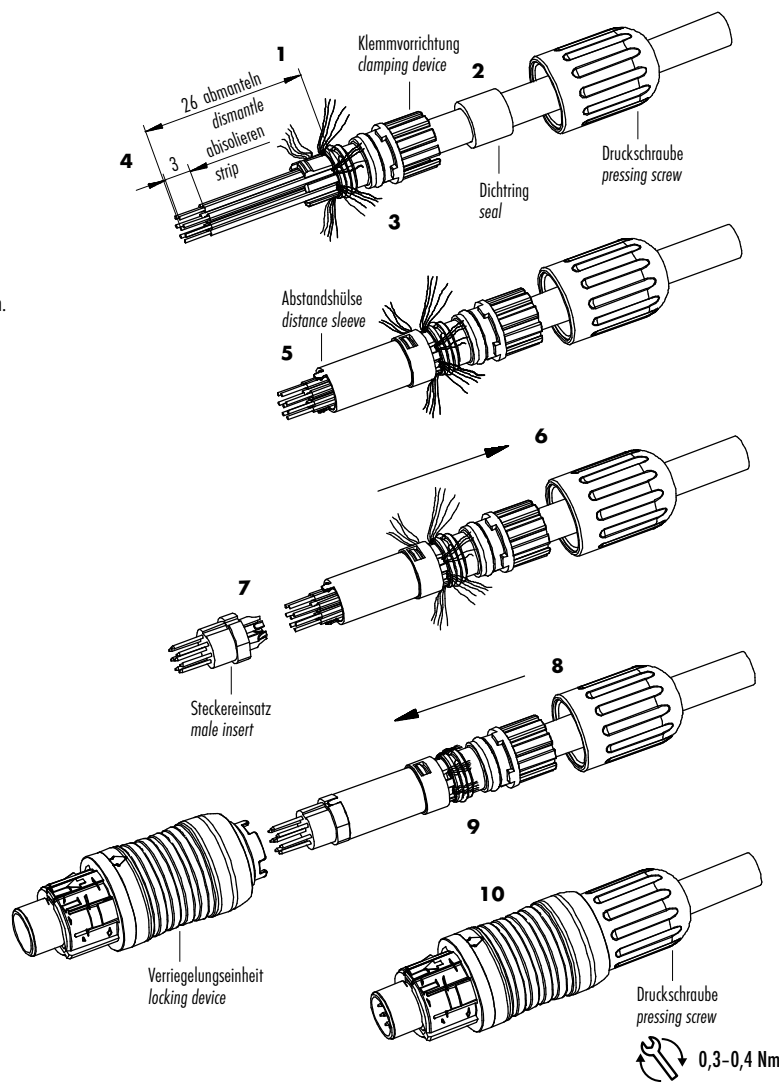

1. Strip to 26mm length but do not take off cable jacket.
2. Bead pressing screw and clamp device to cable. Mount sealing ring to clamp device. Remove cable jacket.
3. Fan out and comb shielding braid.
4. Strip the insulation off the wires and tin them.
5. Snap in distance sleeve and clamp device.
6. Solder wires to solder cups.
7. Stick distance sleeve to sleeve.
8. Push forward and snap in clamp device. Mount shielding braid around the crown.
9. Strip off and shorten shielding braid in the direction of the shielding ring.
too long: shielding braid on sealing ring - untight
too short: no contact to wave washer
10. Insert assembled unit into carrier sleeve. Note the position of the coding nose.
11. Put on and tighten pressing screw.

Einzelteildarstellung
Component part drawing

Flanschsteckverbinder
Panel mount connectors

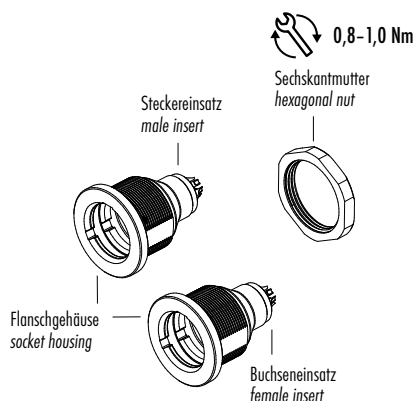

Polbilder
Contact arrangements

Stifteinsatz (Steckseite)
Male insert (mating side)

Buchseinsatz (Steckseite)
Female insert (mating side)

3 pol
3 contacts

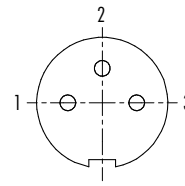
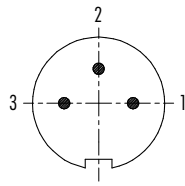

4 pol
4 contacts

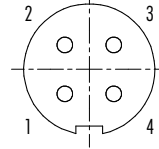
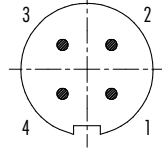

5 pol
5 contacts

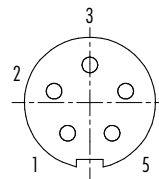
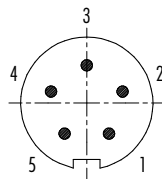

7 pol
7 contacts

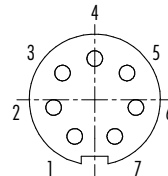
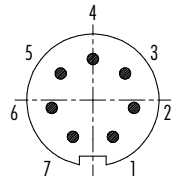

8 pol
8 contacts

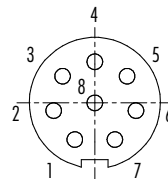
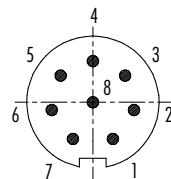

Montageausschnitt
Panel cut out

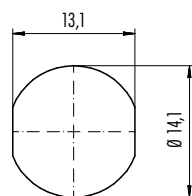

Zubehör Subminiatur 430
Accessories Subminiature

Bezeichnung / Description	Maßzeichnung / Drawing	Bestell-Nr. / Ordering-No.
---------------------------	------------------------	----------------------------

Schutzkappe für Kabelsteckverbinder
Protection cap for cable connectors

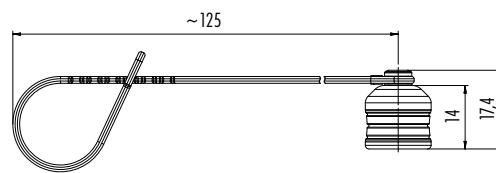

08 2965 000 000

Schutzkappe für Flanschsteckverbinder
Protection cap for panel mount connectors

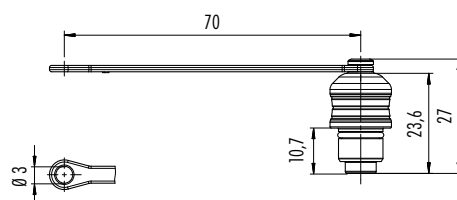

08 2966 000 000